

brother

CREATIVE SEWING GUIDE

Create your LIFE by yourself.



It's Sew Easy!

My First Sewing Machine

The Innov-is A-Series is the perfect sewing machine for beginners.

For the new mom who wants to start sewing,
for her family, or for herself.

For anyone who is interested in creating original items, or upcycling existing items.

You too can create stylish things!

This sewing machine is the host inviting you
into the exciting world of creativity.



A Sewing Machine Just Right for Me

The Innov-is A-Series is ideal for those who think,
„I'd like a new sewing machine to start being creative.“

Home sewing machines are evolving.

No need for unnecessary and fancy features -
these machines are simple but provide solid sewing quality.

Equipped with ample functions that are easy to use by people of any age,
this sewing machine will be your reliable partner in your
creative and happy sewing world.

*To the exciting world,
A navigator who will invite me.*



It's Sew Easy!



Table of Contents

CHAPTER 01 – A-SERIES PROFILE

| | |
|-------------------------------|----|
| A-Series Profile | 08 |
| A-Series Close up Points..... | 10 |

CHAPTER 02 - CREATIONS

| | |
|---|----|
| Creation 01, Big canvas tote bag | 13 |
| Creation 02, Sleeveless top made of lightweight fabric | 16 |
| Creation 03, Long skirt made of lightweight fabric | 18 |
| Creation 04, French-sleeve T-shirt..... | 20 |
| Creation 05, Upcycled frilly T-shirt..... | 22 |
| Creation 06, Buttoned pouch..... | 24 |
| Creation 07, Buttoned napkin ring | 26 |
| Creation 08, Buttoned mini cushion..... | 28 |
| Creation 09, Frock for Kids..... | 30 |
| Creation 10, Synthetic leather bag/key case/zippered pouch..... | 32 |
| Creation 11, Zippered convertible apron | 36 |
| Creation 12, Poncho-style tunic top | 38 |
| Creation 13, Slippers | 40 |

CHAPTER 03 – STITCH AND PROFILE

| | |
|--|----|
| A-Series Built-in Stitch Patterns..... | 42 |
| A-Series Profile | 46 |

CHAPTER 04 – SUPPORTCENTER

| | |
|--------------------|----|
| A-Series App | 48 |
| Movie Index | 49 |



It's Sew Easy!



People all over the world are known to enjoy sewing.

The new Innov-is A-Series was born as the sewing machine for our new generation, based on the beloved successor that has been popular for more than a decade. We listened to our customers and capitalized on the well-received features, while enhancing other functions as well, and updated the design to an even more user-friendly version.

By developing this sewing machine our main goal was to increase the number of people worldwide who enjoy the art of sewing! Since this machine is aimed at beginners, we kept in mind that the beginner would also want to experience an enjoyable and fun sewing experience, but with great sewing quality.

Although the Innov-is A-Series is a simple and affordable sewing machine which is a good introduction to the world of sewing, it was designed to last for many years to come.

CHAPTER

01

A-SERIES

Innov-is A-Series Profile

Clear threading diagram on the body

Simply follow the numbers and clear threading illustrations for quick and stress-free threading. Refer to page 10.



Advanced needle threading

Threading the needle is easier than ever before with the advanced one-action needle threader.



Superior lockstitch function

At the touch of a button, tie-off stitches can be easily sewn at the beginning and end of the stitch.

Convenient needle up/down button

Press the button to raise the needle to its highest position or lower it. Pressing the button twice sews one stitch.

You can also change the stop position easily by long pressing the button (available in A16, A50, A60SE and A80).

Automatic thread cutter

Neatly trim threads at the end of sewing with the auto thread cutter. No more excess threads to trim afterwards!

Only available in A150

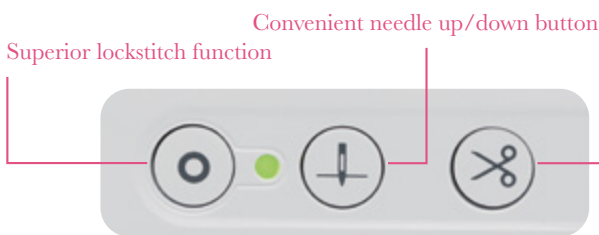

Automatic thread cutter

Thread tension

Superior sewing quality

Refer to page 11.

Flat bed for various sewing styles

The flat bed of the machine lets you sew in various styles. Removing the flat bed attachment allows for free-arm sewing, making it easier to sew tubular items such as sleeve cuffs and trouser legs. You can also sew like a professional dressmaker using a wide table (optional ACC) that helps you work with bulky fabrics.



Standard

Easy bobbin winder with thread cutter

No need to keep hold of the thread while winding the bobbin.



Friendly and versatile user interface



A50 A60 A80 A150

Super easy stitch selection

Quickly select your desired stitch pattern by simply turning the dial or touching the keypad.

A80 and A150 models also come with a stitch pattern plate.



A80



A150

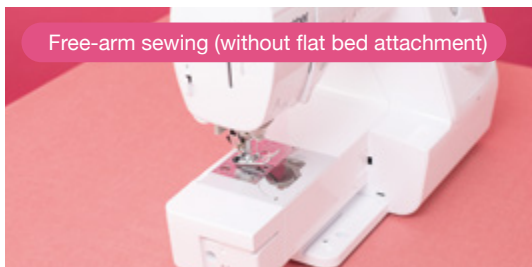

Free-arm sewing (without flat bed attachment)



With wide table WT15 (optional ACC)

Innov-is A-Series Close up Points

Innov-is A-Series offers great sewing quality. It allows our customers to make beautiful creations.

01 Fuss-free threading

Easy-to-understand graphics on the machine are numbered to easily guide beginners and long-time users alike. No more confusion! Diagrams on the machine help with machine threading, bobbin installation, how to wind bobbins, as well as the handling of thread guides and thread directions that tends to be done incorrectly.



The indications for machine threading start with the direction from the spool. Bobbin winding is also indicated with numbers.

02 Easy needle threading

Thread the needle with one push of a lever! Guide the thread, and then press down on the lever and voilà!

This easy feature works for anyone. Even when you need to frequently change the thread to match the fabric, such as when sewing patchwork, you will no longer be inconvenienced.



Helpful navigation up to needle threading.



Lower the presser foot. Make sure that the needle is raised.



Press the lever!



Easy sew items with frequent thread colour changes.



Bobbin installation is also indicated with arrows.

03 Super sewing quality

With the improved feed dogs and longer J-foot as well as the extra powerful needle penetration, stitches are smooth and consistent on thin and thick fabrics.

J foot was made longer and less curved to allow for smooth sewing.

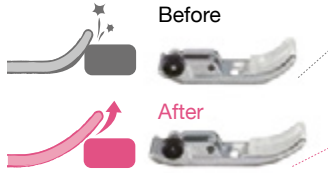

Longer and extra feed dogs ensure a smooth feeding action and superior stitch quality.

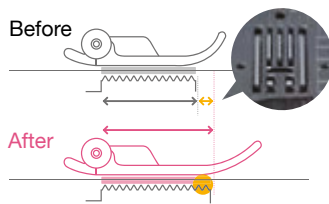

04 Sharp feed dogs

Sharp feed dogs are compatible with a variety of fabrics, from heavyweight fabrics such as denim and canvas to lightweight fabrics such as georgette and organdy as well as stretch fabrics such as jersey and T-shirt fabric.



05 High-quality zigzag stitching

Haloing (upper thread looping) is prevented with a brush hidden at the back of the needle plate. This makes for great quality zigzag stitching.





CHAPTER

02

CREATIONS



Innov-ís A-Series Creations

The Innov-ís A-Series offers stability allowing proper sewing of heavyweight or overlapping fabrics. From fashion to interior accessories, the scope of home sewing is ever increasing.

 [Click here for instruction videos](#)

Applications



The presser foot locking pin keeps the presser foot level. Smoothly sew even thick seams.



Cleanly sew the overlapping sections of denim and canvas with the outstanding penetration power.



Change the hem length of your jeans. Small amendments to bulky items are easy.

Use denim sewing thread with needles #14 to #16 for a professional finish.

CREATION 01 Easily sew
heavyweight
fabrics.

Want an everyday bag to be the first item you make as a beginner? Stitching of bulky or thick fabrics is one of the new A-Series strong points.

You can easily sew a strong strap to a canvas tote bag. Sew decorative tape to a pocket or decorate with stitching, and be sure everyone will be asking “Where did you buy that?”



Big canvas tote bag

1. If there are no instructions to use a specific stitch, use the straight stitch.
2. Presser foot "J" (straight stitch/zigzag stitch) and overcasting foot "G" will be used.



Materials

- Medium weight canvas (82 cm wide × 108 cm)
- Sequin tape (4 to 5 mm wide × 95 cm)
- Lamé tape (4 to 5 mm wide × 70 cm)
- Strap for handles (4 cm wide × 3 m)

Cutting diagram

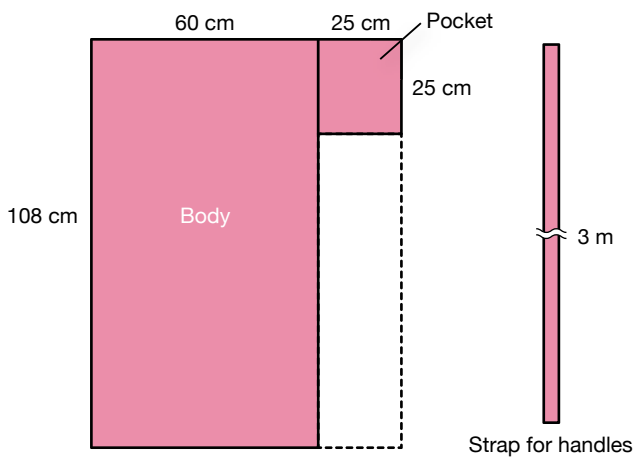

- 1 Sew overcast stitching (for heavy-weight fabrics) along the edges of the body and pocket.

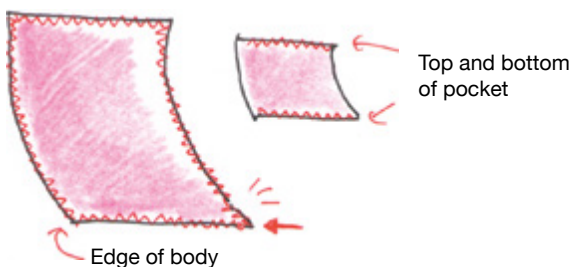

- 2 Fold over the top and bottom of the pocket and stitch.

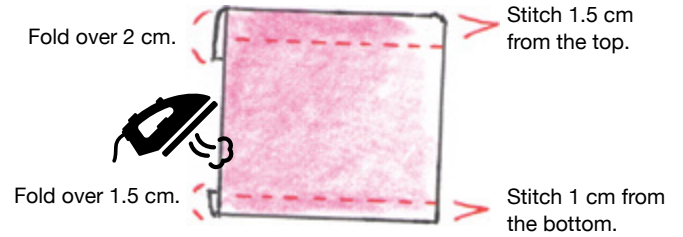

- 3 Sew on the lamé tape with a zigzag stitch. Sew on three pieces equally spaced.

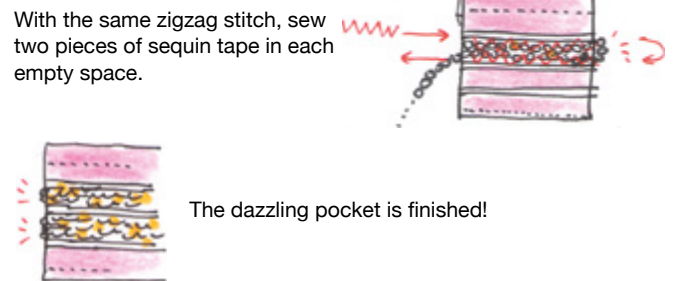
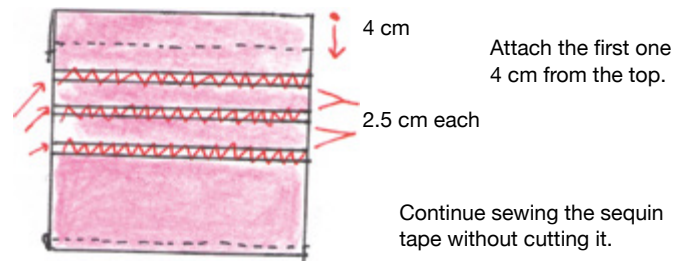

- 4 Stitch the opening of the body, and then sew on the pocket.

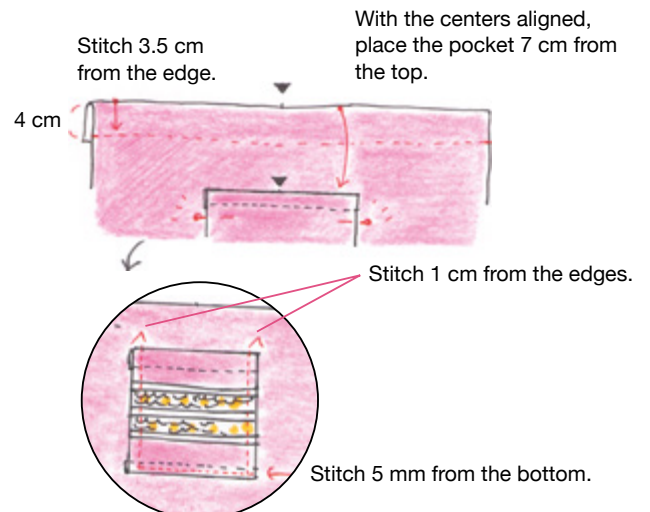

- 5** Place the strap for the handles over the sides of the pocket, and then stitch along the inside and outside of the strap. Sew X-shaped reinforcements at the openings of the body. After all other stitching is finished, sew the ends of the strap together with a zigzag stitch.

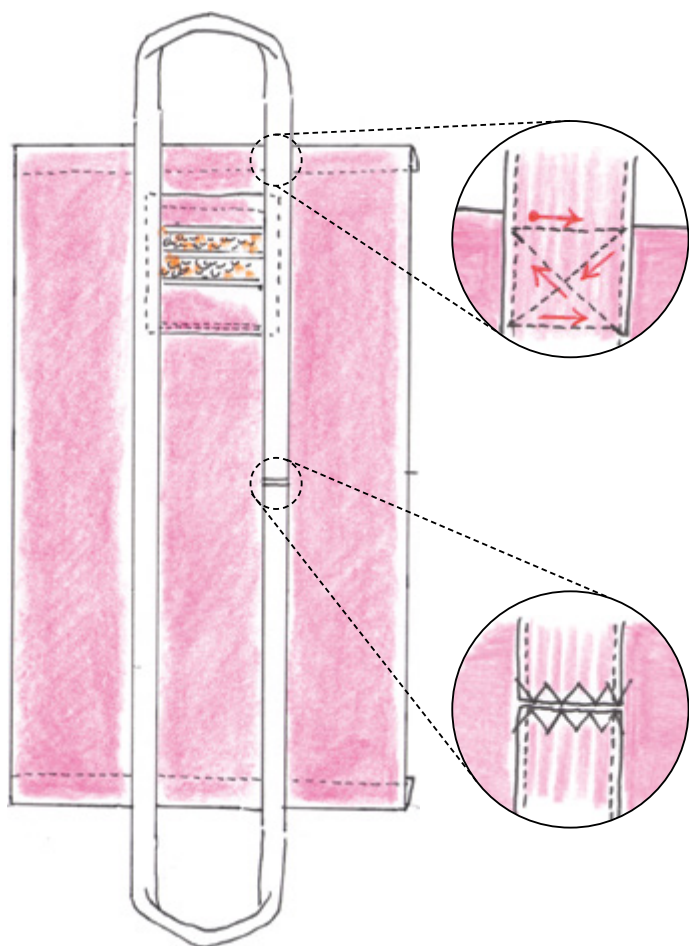

- 6** Fold in half with right sides together, and then stitch along both sides.

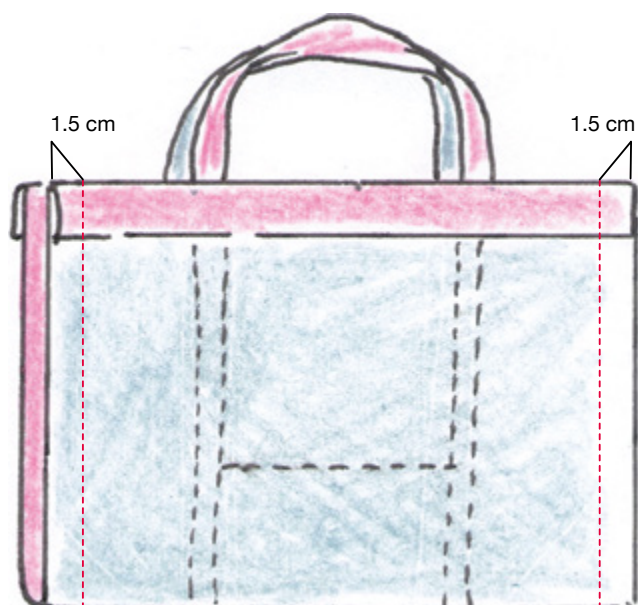

- 7** Stitch the gussets. Open the opening to the front and back, and then fold the bottom corner to form a triangle. Sew straight stitching perpendicular to the seam so that the stitching has a width of 25 cm.

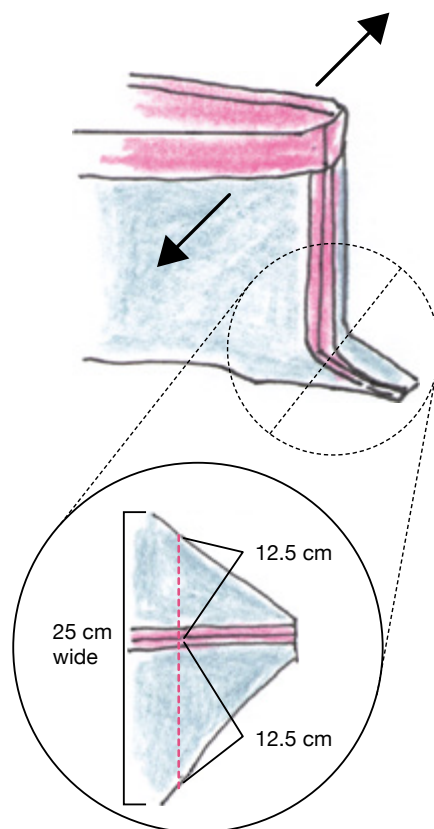

- 8** Turn right side out, and then sew overlapping stitching at the opening to reinforce the side seams.

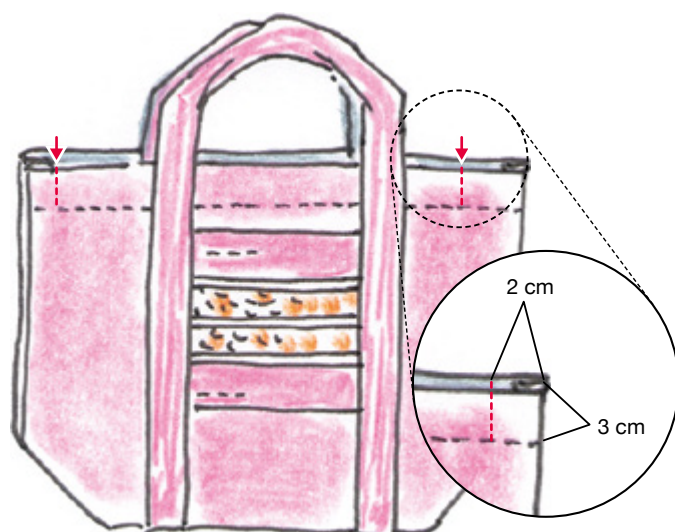

Sew back and forth 2 to 3 times.

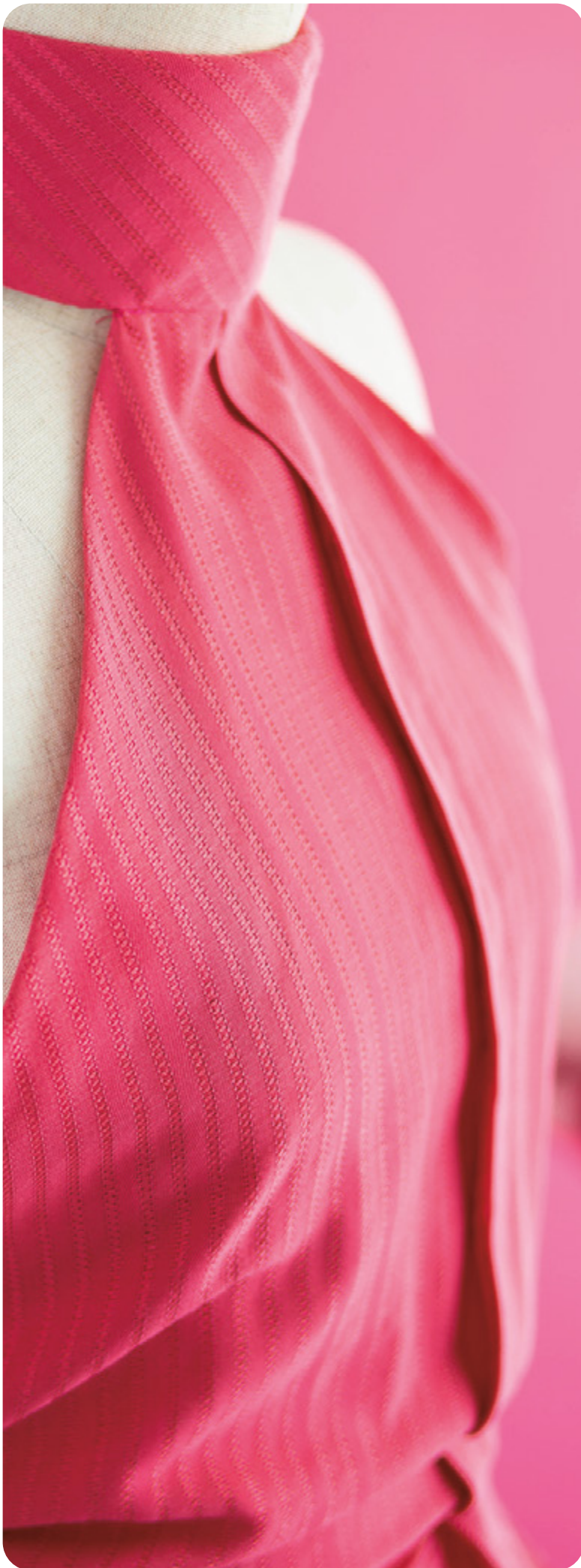

CREATION
02 Neatly sew
lightweight
fabrics.

Some people tend to shy away from lightweight fabrics which are thought to be difficult to sew. However, the Innov-is A Series can neatly finish elegant, fashionable clothes made from lightweight fabric.

Get straight to sewing a variety of fabrics, such as georgette or organdy, to make party dresses or children's clothes for events. Going out in unique garments is no longer just a dream!



Sew a variety of fabrics without adjusting the presser foot pressure.

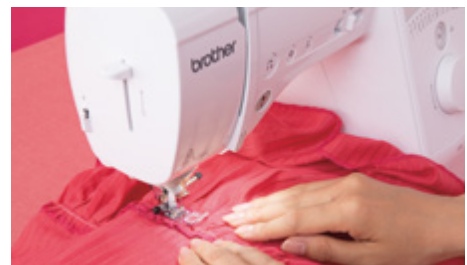

For delicate fabrics like organdy, install a needle and thread for lightweight fabrics.

Use thread for lightweight fabrics with needles #9 to #11.

Sleeveless top made of lightweight fabric

1. If there are no instructions to use a specific stitch, use the straight stitch.
2. Presser foot "J" (straight stitch) will be used.



Let's make a sleeveless top from lightweight fabric. Wear this top together with the skirt as a gorgeous party set.

Materials

- Cotton voile (60 cm square) – 3 pieces

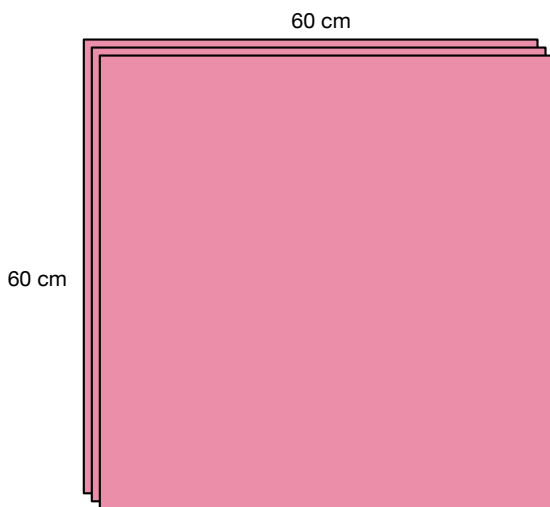

- 1 Prepare all three pieces by folding back 5 mm twice and stitching along all edges to make 58 cm square handkerchiefs.

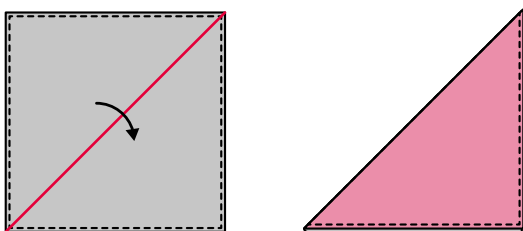

Fold all three pieces into triangles.

- 2 Overlap two pieces, and then sew them together.

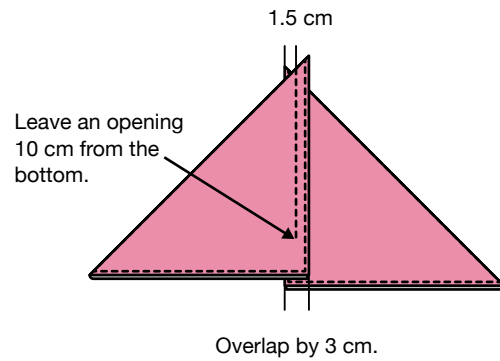

- 3 Place the third piece at the top of the piece made in step 2 to make a neckband. Sew the third piece onto the piece made in step 2 so that the width of the overlap is 10 cm.

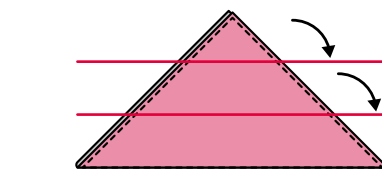
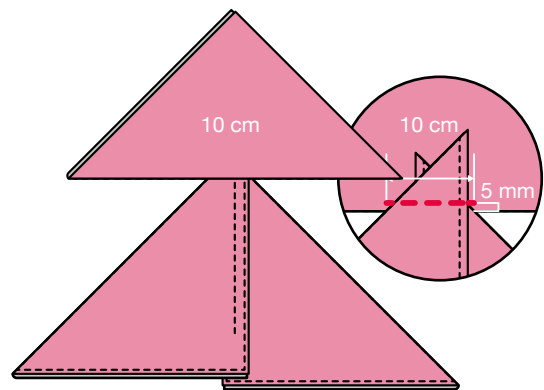

Fold to the inside, and then sew blind hem stitching by hand.

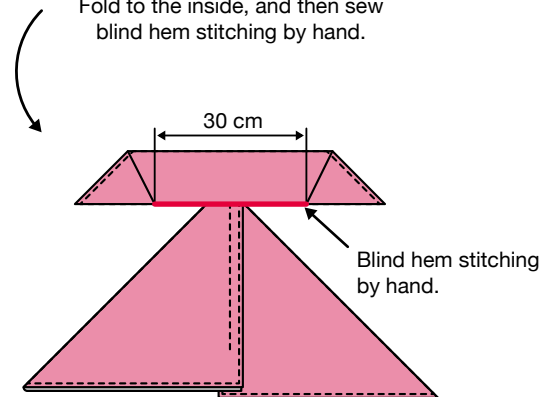

Wear tied around the neck and waist.

CREATION
03 Neatly sew
lightweight
fabrics.



Long skirt made of lightweight fabric

1. If there are no instructions to use a specific stitch, use the straight stitch.
2. Presser foot "J" (straight stitch) and overcasting foot "G" will be used.



Let's sew a three-tiered long skirt made of lightweight fabric. If you have plenty of fabric, you can sew straight lines to connect square pieces to make fashionable clothes to wear to a party.

Materials

- Cotton voile (120 cm wide × 175 cm)
 - Elastic tape (2 cm wide × 65 cm)
- Prepare a length of the waist size + 2 cm.

Cutting diagram

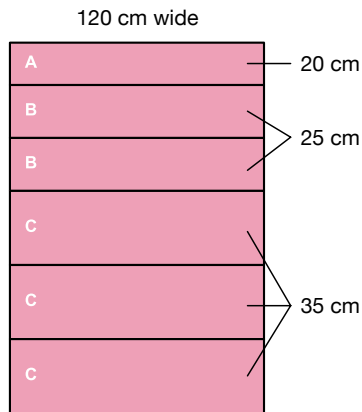

- 1 Cut out each piece. Use the selvage on both ends.

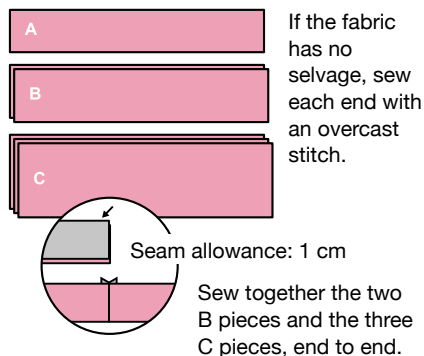

- 2 Sew overcast stitching along the edges of the pieces that were sewn together.

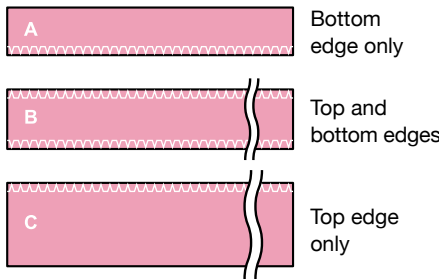

- 3 In order to create gathers, machine-baste (straight stitching with a long stitch length) along the top edges of B and C.

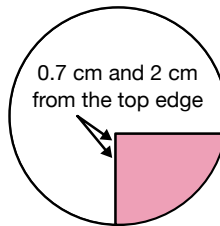

Pull both ends of the thread to create gathers.

- 4 Sew together the pieces.

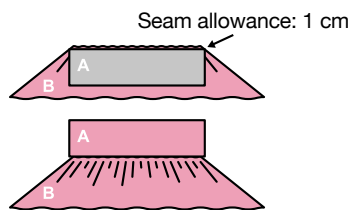

Adjust the length of the gathered top edge of B to the length of the bottom edge of A, pin them together, and then stitch together.

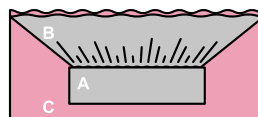

Adjust the length of the gathered top edge of C to the length of the bottom edge of B, pin them together, and then stitch together.

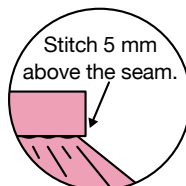

Fold up the seam allowances, iron them, and then sew them in place by stitching from the right side.

- 5 Sew the ends together to form a tube.

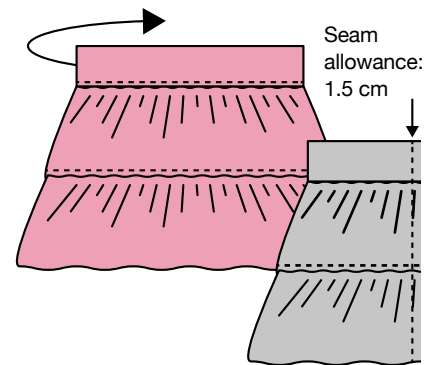

- 6 Fold back twice and stitch at the waist and hem. In order to pass the elastic tape through, leave a 5 cm opening on the side of the waist.

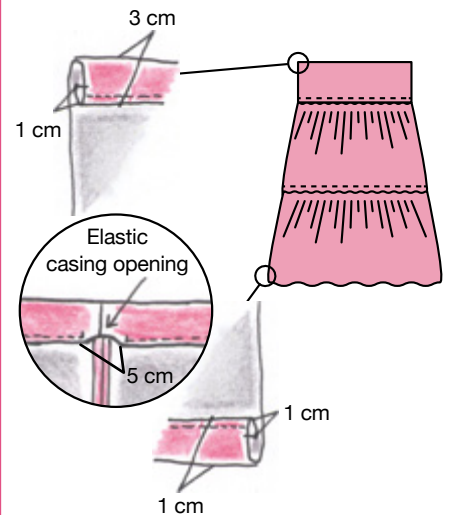

- 7 Pass the elastic tape through to complete the project. Overlap 5 cm of the elastic tape, and then sew together with a stretch stitch.

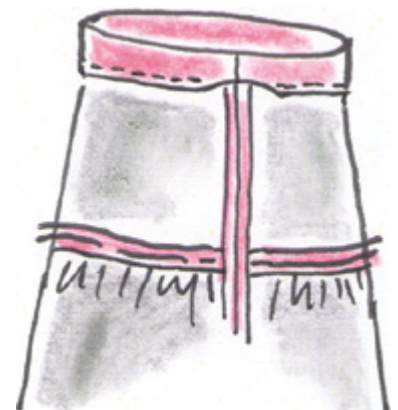



Using a stretch stitch,
even beginners can achieve
a beautiful finish!

CREATION

04

Effortlessly sew even
stretch fabrics!

Sew your own casual garments and baby items from cut-and-sew fabrics, such as sweatshirts and T-shirts and knit fabrics with draping properties. Link up and coordinate with parents and siblings to nicely finish upcycled T-shirts.

French-sleeve T-shirt

1. If there are no instructions to use a specific stitch, use the straight stitch.
2. Presser foot "J" (straight stitch/zigzag stitch) and overcasting foot "G" will be used.

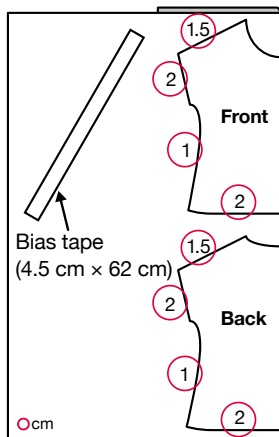

Materials

- Jersey fabric (110 cm wide x 125 cm)
Use fabric that does not have edges that roll up when it is cut.
- Machine thread for knit fabrics

Cut while adding the seam allowances indicated in ○.

There is no seam allowance at the neckline.

Bust size: 75 to 85 cm

First, draw and prepare paper patterns, as shown below.

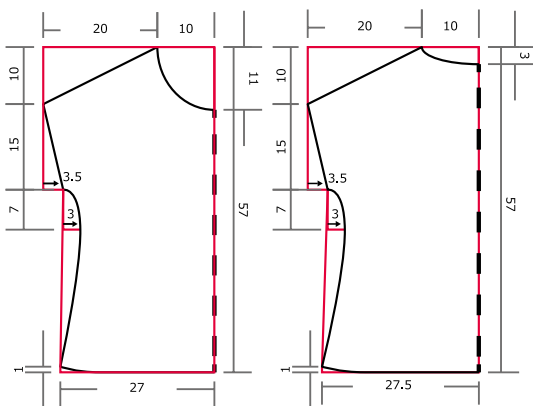

- 1 Sew overcast stitching along the body of the front and back.

Sew overcast stitching along the shoulders, sleeves and hem.

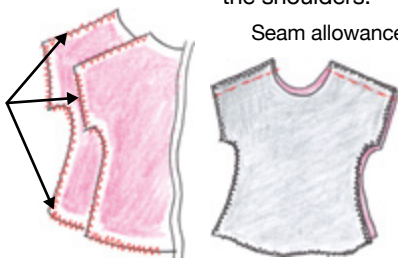

- 2 With their right sides together, sew together the front and back along the shoulders.
Seam allowance: 1.5 cm

Seam allowance: 1.5 cm

- 3 Fold over the sleeve hem, and then sew with an elastic zigzag stitch.



- 4 Form a ring with the bias tape, and then sew it to the neckline.

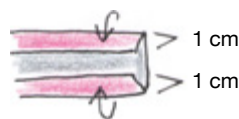

Fold over both edges and iron, and then open again. Sew together both ends to form a ring.

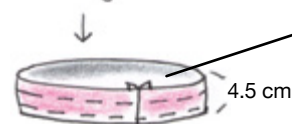

Form a ring with a 1 cm seam allowance.

Starting from the center of the back, sew 1 cm from the edge.

Fold the bias tape to the right side, and then sew one line of stitching along the edge.

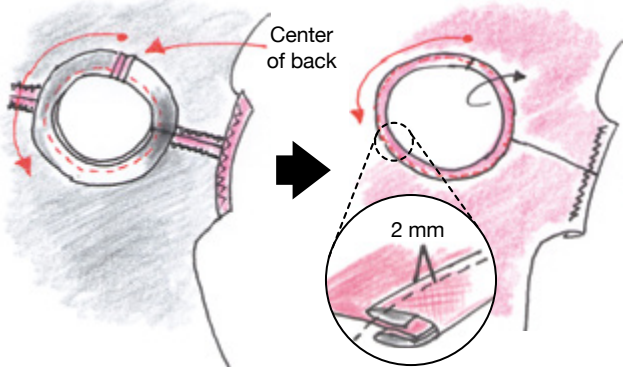

- 5 With their right sides together, sew along the sides.



- 6 Fold over the hem, and then sew with an elastic zigzag stitch.



Done!

CREATION

05

New from Old.

Upcycled frilly T-shirt

1. If there are no instructions to use a specific stitch, use the straight stitch.
2. Presser foot "J" (straight stitch) will be used.



4. Fold up the hem twice, and then sew with a Stem stitch.

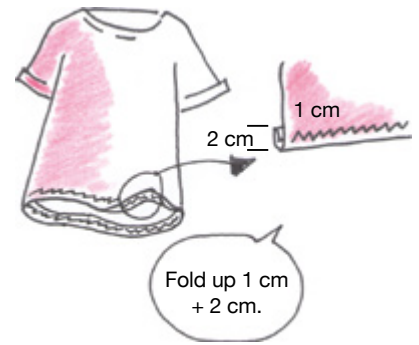

5. Set up the sewing machine for free-arm sewing, and then sew the ruffles onto the T-shirt.



For details on free-arm sewing, refer to the manual for your sewing machine.

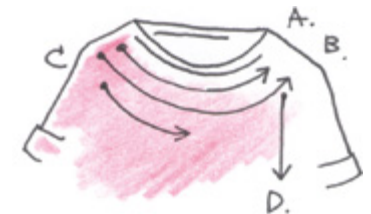

Fold back the fabric at the beginning and end of stitching, and then sew reverse stitches.

Sew only 4 to 5 cm of D in place, then allow the rest to hang down. Simple ruffles complete this gorgeous T-shirt!!



Once you better know your sewing machine



In the video, ruffles are made by feeding the fabric with an awl. Gathers can be created by pushing in the fabric in front of the presser foot.

Materials

- Long T-shirt – 1 piece



Cut off the hem at the finished length + 3 cm.

1. Use a long T-shirt so at least 12 cm can be cut off. If a short T-shirt is used, make the ruffles with other fabric.



2. Cut three pieces with a width of 3 to 4 cm from the portion to make ruffles. The original hem will not be used.

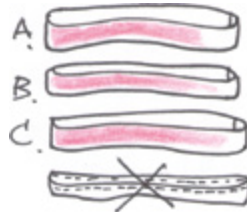

Cut C in half to make two pieces. One of those pieces will become D.

3. Cut the side seams of A and B to make strips.



Use a sewing machine to sew rough straight stitching along the center. Leave excess thread on both ends.



Pull the threads to reduce the length of each strip (A to D).

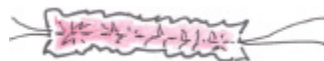

Four frills are made.

- A. 35 cm
- B. 45 cm
- C. 20 cm
- D. 25 cm

A different method for making the ruffles is shown in the video.



CREATION

06

Sew buttonholes.

Buttonholes can be used not only to fasten buttons on clothes and accessories but also as accents on your project as well as for decorative sewing. Automatically sew a buttonhole the size that matches the button.

Tips



Attach stabilizer for a neat finish on lightweight and delicate fabrics. Be sure to lower the buttonhole lever.

Buttomed pouch

1. If there are no instructions to use a specific stitch, use the straight stitch.
2. Presser foot "J" (straight stitch) and buttonhole foot "A" will be used.



This mini-bag-type pouch can be used for carrying cosmetics and accessories. Try altering it, for example, by making it larger or orienting it vertically, to fit your needs. Buttonholes that are not cut open can be used as decoration, but here they are useful for securing the pouch with buttons.

Materials

- Outside fabric (tweed, 17 cm wide × 26 cm)
- Lining fabric (cotton/linen, 16.5 cm wide × 25 cm)
- Flap (plain-weave canvas, 13 cm wide × 22 cm)
- Stabilizer (for mediumweight fabrics, 11 cm × 10 cm)
- Decorative buttons (approx. 1.8 cm diameter) – 2 pieces

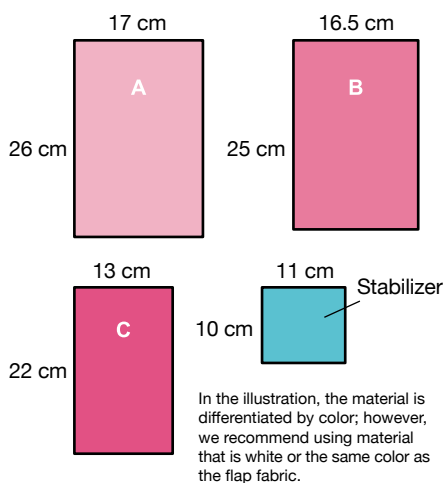

-  2 buttons (1.8 cm diameter)

- 1 Separately fold A and B in half with their right sides together, and then stitch along each side.

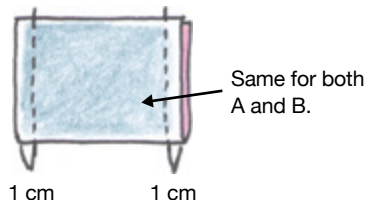

- 2 Fold over 1 cm at the openings of A and B, and then iron them.

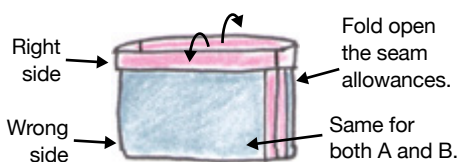

- 3 Turn A right side out, and then place B inside. Align the side seams, and then pin in place.

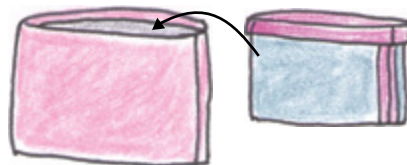

- 4 Sew one line of stitching around the opening of A 5 mm from the edge.



- 5 Make the flap. Iron stabilizer to the wrong side of C.

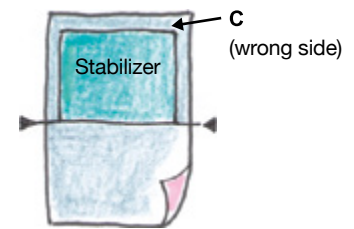

- 6 Fold in half with right sides together, and then stitch along both sides.

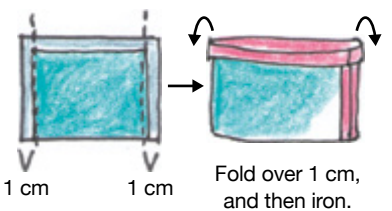

- 7 Turn right side out, and then sew buttonholes to fit the size of the decorative buttons.



For details on free-arm sewing, refer to the manual for your sewing machine.

- 8 Stitch along the opening and edges.

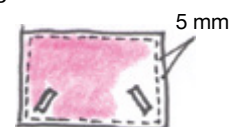

- 9 Attach the flap to the body.

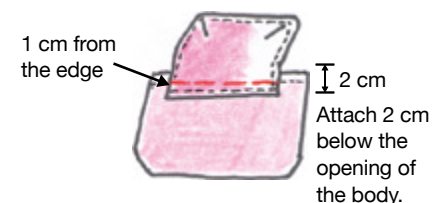

- 10 Sew on the buttons by hand.

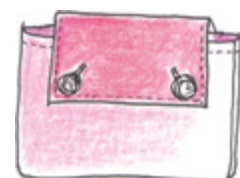

CREATION

07

Sew more
buttonholes.



Buttomed napkin ring

1. If there are no instructions to use a specific stitch, use the straight stitch.
2. Presser foot "J" (straight stitch) and buttonhole foot "A" will be used.



This napkin ring is like a simple buttoned belt. Use fabric in a variety of colors or colorful patterns. Some models cannot sew characters like those on the napkins.

Materials

- Cotton (26 cm wide × 12 cm)
- Stabilizer (24 cm wide × 5 cm)
- Button (2 cm diameter)

Prepare the required quantities for the expected number of people.

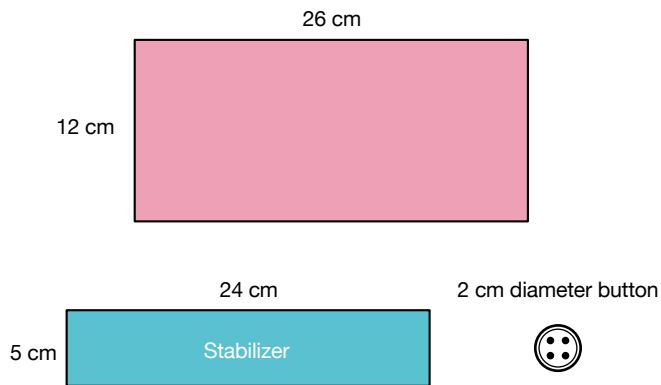

1 Affix stabilizer to the wrong side of the fabric.

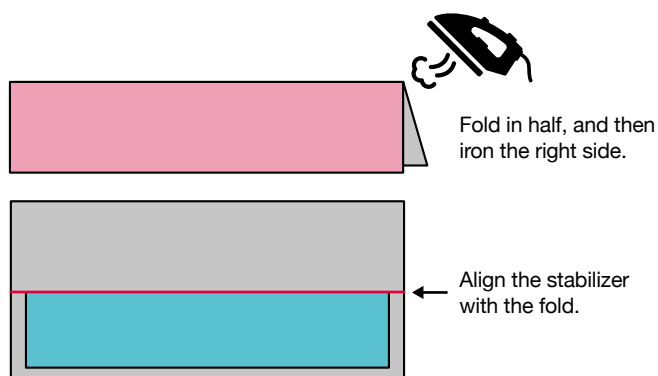

2 Fold in half with right sides together, and then stitch along the edges.

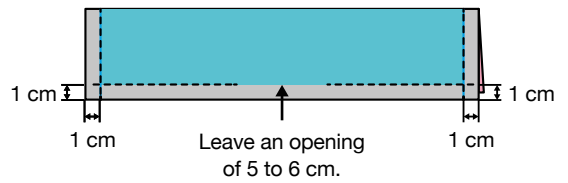

3 Turn right side out, iron the fold, and then stitch along the edges.



4 Sew buttonholes.

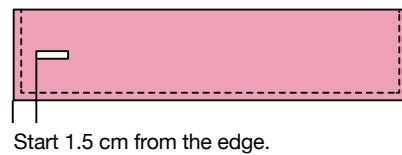

For details on free-arm sewing, refer to the manual for your sewing machine.

5 Attach the button to complete the project.



This length is for a 45 cm square napkin. Change the position of the button and the length of the belt to fit your napkin.





CREATION

08

Style your Home.

Buttressed mini cushion

1. If there are no instructions to use a specific stitch, use the straight stitch.
2. Presser foot "J" (straight stitch), overcasting foot "G" and buttonhole foot "A" will be used.



Materials

- Main fabric (65 cm wide × 21 cm)
- Other fabric (20 cm wide × 21 cm)
- Sheeting (72 cm wide × 20 cm)
- Buttons (2 cm diameter) – 2 pieces
- Cotton batting

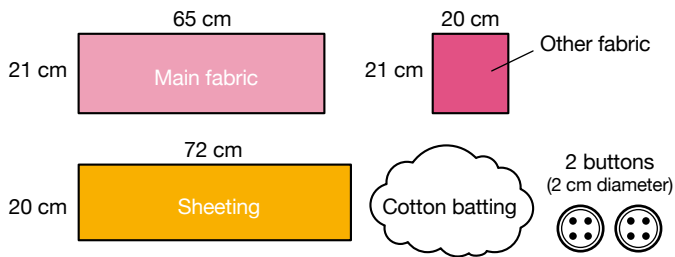

1 Make a plain cushion with the sheeting.

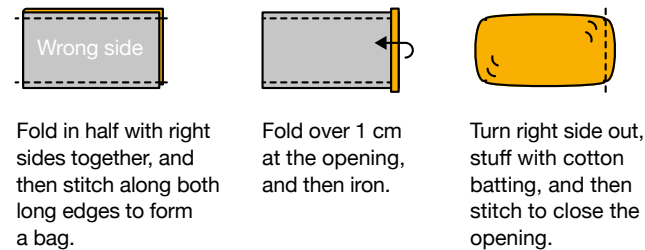

2 Sew the edges of the main fabric and other fabric with an overcasting stitch.



3 Sew together the main fabric and other fabric with their right sides together.

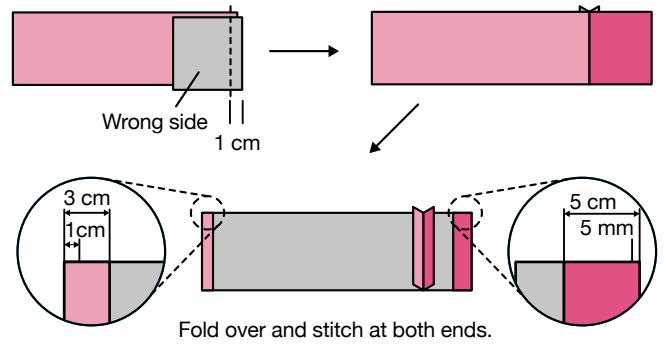

4 Sew buttonholes in the folded portion of the other fabric.



For details on free-arm sewing, refer to the manual for your sewing machine.

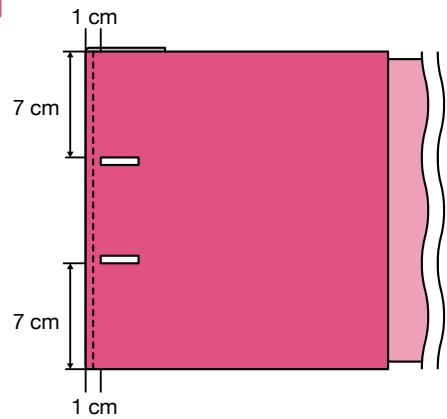

5 Fold over, and then stitch along the top and bottom.

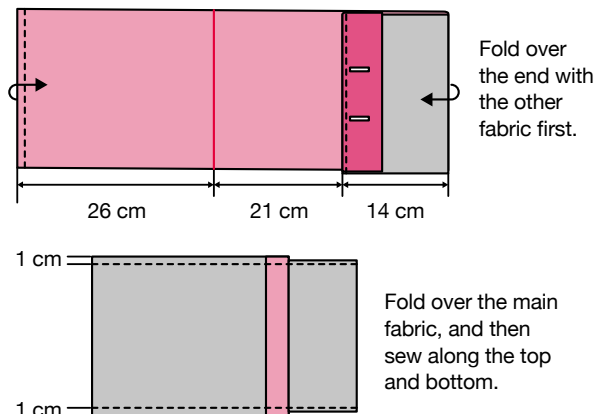

6 Turn right side out, sew on buttons, and then insert the plain cushion to complete the project.

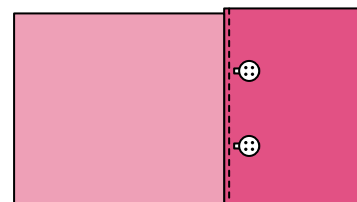

CREATION

09

Pretty in Pink.



Frock for Kids

1. If there are no instructions to use a specific stitch, use the straight stitch.
2. Presser foot "J" (straight stitch), overcasting foot "G" and the Concealed Zipper Foot F080 (sold separately) will be used.



Materials

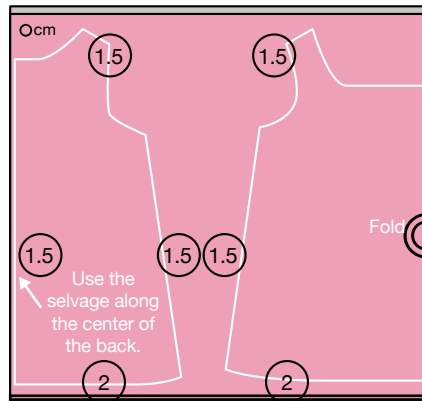

- Cotton fabric (110 cm wide x 55 cm)
- Bias tape (11 mm wide x 130 cm)
- Concealed (invisible) zipper (20 cm)

Cut while adding the seam allowances indicated in O. (There are no seam allowances at the neck opening or armholes.)
Size: 90 cm height

First, draw and prepare paper patterns, as shown below.

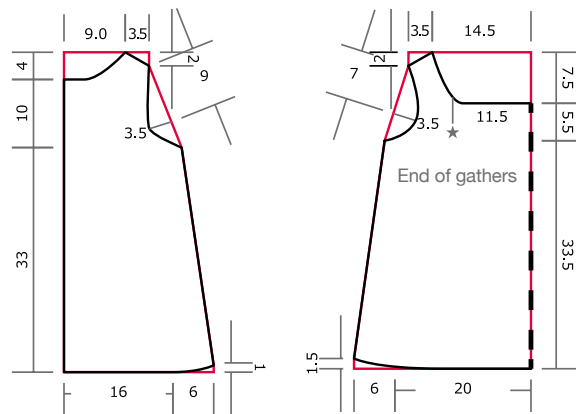

- 1 Sew overcast stitching along the shoulders and sides.



- 2 Stitch along the center of the back to the zipper opening.

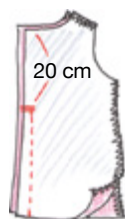

Sew reverse stitches at the beginning and end of stitching.

- 3 Sew on the concealed (invisible) zipper.

Align the end of the zipper with the finished edge.

Attach inside out on the seam allowance of the fabric.

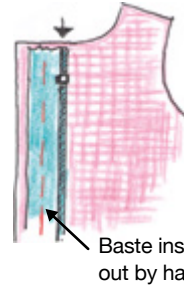

Baste inside out by hand.



Sew the edges of the zipper.

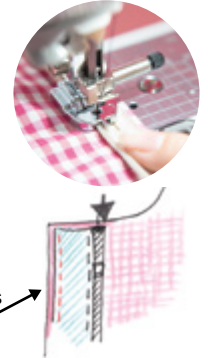

- 4 Gather at the front of the neckline. Use a sewing machine to sew rough straight stitching, and then pull both ends of the thread to reduce the section between ★ and ★ to 10 cm.

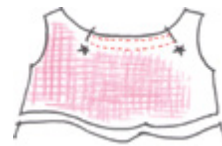

- 5 With their right sides together, sew together the front and back along the shoulders.



- 6 Cover the neckline with bias tape.

Align the edge at the neck opening.

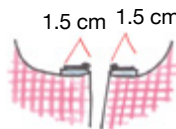

Open the zipper.



Fold back 1 cm.

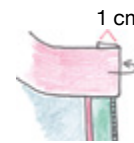

Fold over the edges of the center of the back, place the bias tape on the wrong side, and then stitch along the first fold from the top.

Fold the bias tape up, and then fold back 1 cm at the end.

Fold the bias tape in four along the folds, and then stitch the edge of the tape from the right side.

- 7 In the same way as described in step 6, cover the armholes with bias tape.



- 8 Stitch along the sides.



- 9 Fold up the hem twice and stitch.



Fold up 1 cm + 1 cm.

CREATION

10 Sew easily and beautifully with optional presser feet!

Beginners can easily sew complicated zipper insertions, hard-to-sew vinyl and synthetic leather with special presser feet (optional). Once zipper insertion has been mastered, the level of completion of your projects will increase dramatically. Specialized presser feet can nicely sew special materials!



Applications



Specialized presser foot can be guided over a concealed zipper - easy enough for anyone to sew neat finishes.



With the zipper foot, zippers can be skillfully inserted. You can also sew vinyl and synthetic leather.

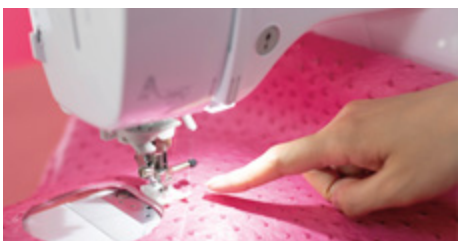

With a specialized presser foot, vinyl and synthetic leather can be smoothly sewn.

Synthetic leather bag

1. If there are no instructions to use a specific stitch, use the straight stitch.
2. Presser foot "J" (straight stitch) and the Non-Stick Foot F007N (sold separately) will be used.



Materials

- Synthetic leather (45 cm wide × 100 cm)
- Stabilizer (43 cm wide × 13 cm) – 2 pieces
- Cardstock (circle of 8 cm in diameter)

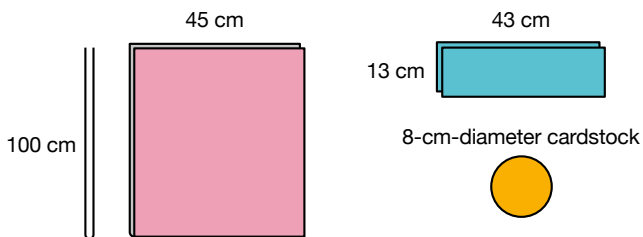

1 Affix stabilizer to the portions to be folded over.

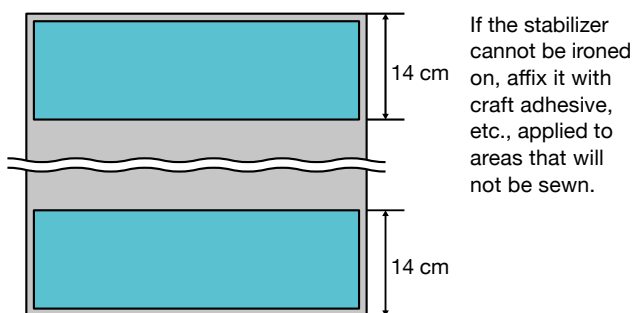

2 Fold over, and then stitch along the top and bottom and around a circle for the handle opening. (Do the same on both ends.)

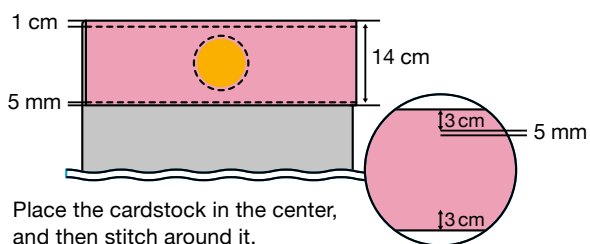

3 Cut circles out of the handles.

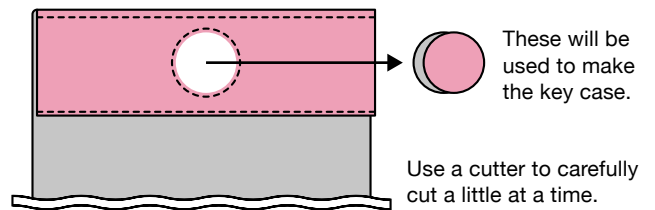

4 Fold the body in half, and then stitch along the sides.

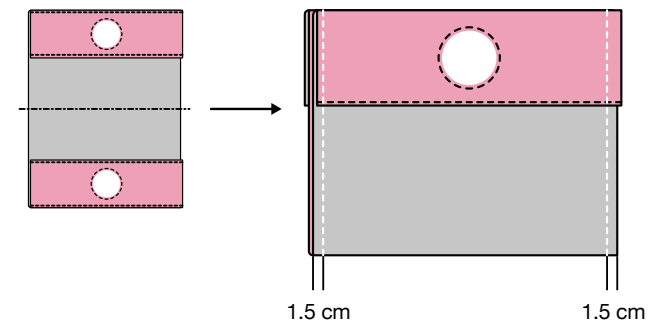

5 Turn right side out to complete the project.

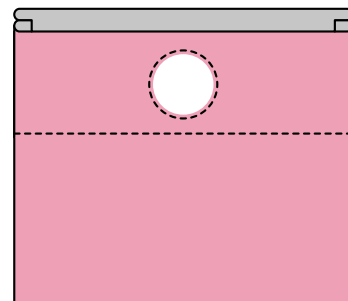

Use the Roller Foot F066 (sold separately) or Non-Stick Foot F007N (sold separately) for smooth sewing of synthetic leather.



Synthetic leather key case

1. If there are no instructions to use a specific stitch, use the straight stitch.
2. Presser foot "J" (straight stitch) and the Non-Stick Foot F007N (sold separately) will be used.



Materials

- Synthetic leather (circle of 8 cm in diameter) – 2 pieces
- Cord (3 mm thick, 45 cm long)
- Scrap of material for a tag* (2 cm × 4 cm)

* Any scrap of material, for example, the same fabric or felt, can be used.

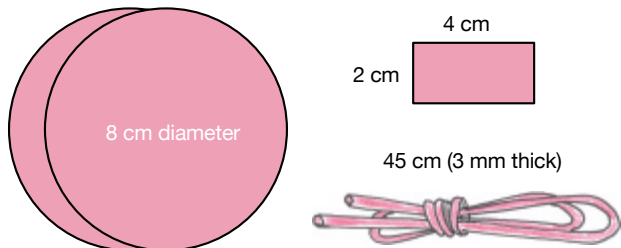

- 1 With their right sides out, stack the round pieces of synthetic leather, and then stitch them together. If the material does not feed well, use the separately sold Roller Foot F066 or Non-Stick Foot F007N.

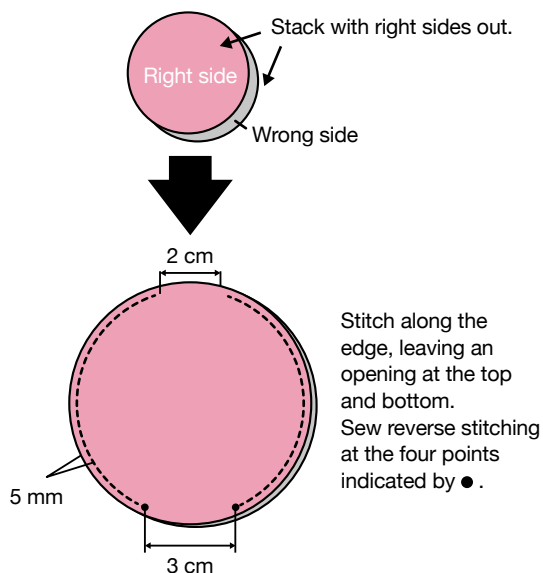

- 2 Sew down the center of the top opening.

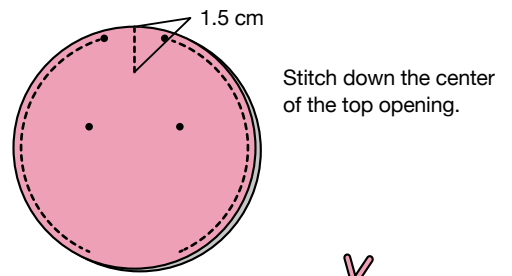

- 3 Pass the cord through, and then tie the ends together.

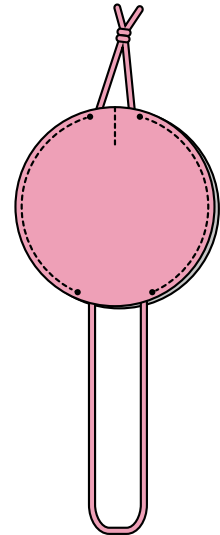

- 4 Sandwich the knot in the excess scrap material and stitch.

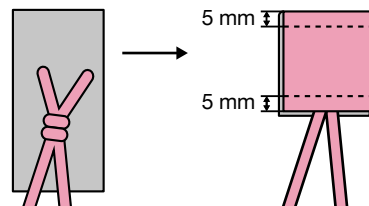

- 5 Attach the keys.

Pull the cord to store the keys inside the case.

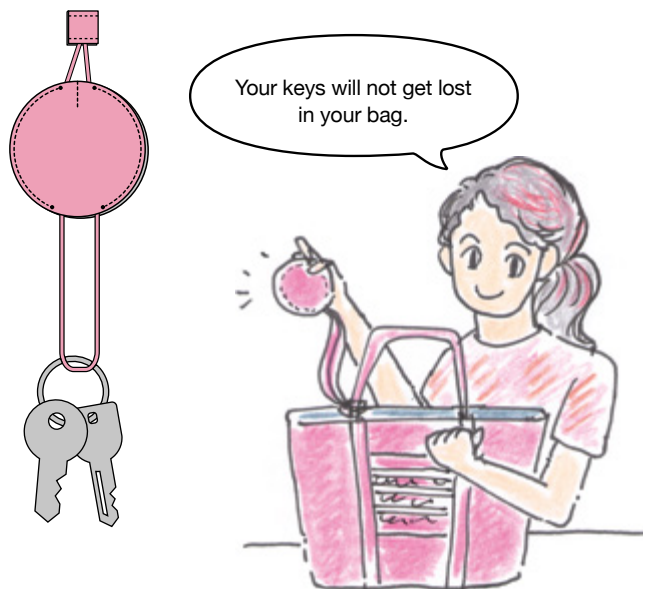

Synthetic leather zippered pouch

1. If there are no instructions to use a specific stitch, use the straight stitch.
2. Presser foot "J" (straight stitch) and zipper foot "I" will be used.



Use ostrich print (embossed) synthetic leather. After mastering zipper insertion, you will be able to make high-quality pouches on your own.

Materials

- 20 cm zipper with bead pull – 1
- Synthetic leather (23 cm wide × 28 cm)

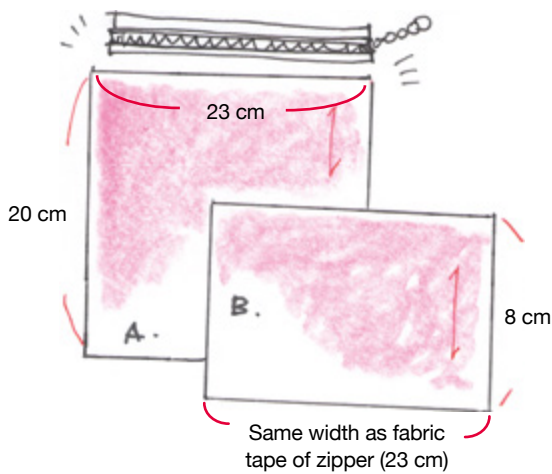

1 Attach the zipper.

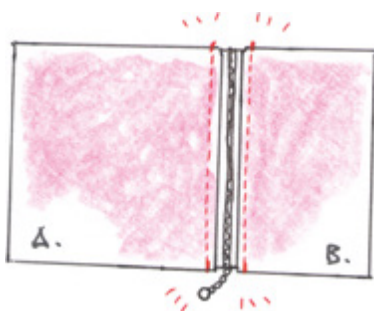

Use the zipper foot „I“ or Narrow Zipper Foot F079 (sold separately) to attach the zipper so that it connects A and B, laying flat.

2 Stitch to form a tube.

Sew the two pieces together from the wrong side.

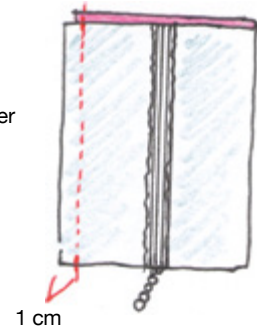

3 Turn right side out, and then stitch along the seam.

It's easier to sew with the zipper opened.



Fold open the seam allowance and stitch.

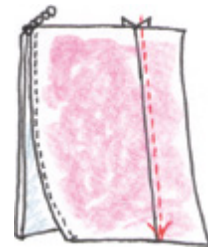

4 Turn wrong side out, stitch along both sides, and then turn right side out again.

Slightly open the zipper.

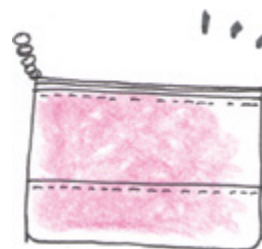
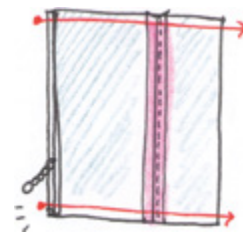

Done!
The stitching is what makes this project neat.

If clean stitching cannot be achieved, use the Roller Foot F066 (sold separately) or Non-Stick Foot F007N (sold separately) to smoothly feed and beautifully sew synthetic leather.

CREATION

11

Have fun
with zippers.



Zippered convertible apron

1. If there are no instructions to use a specific stitch, use the straight stitch.
2. Presser foot "J" (straight stitch/zigzag stitch), zipper foot "I" (or separately sold Narrow Zipper Foot F079) will be used.



Materials (Waist size: 60 cm)

- Medium weight canvas (75 cm wide × 90 cm)
* Waist + 15 cm
- Open-end zipper (70 cm wide)
- Strap (4.5 cm wide × 90 cm)
- Hook-and-loop fastener (2 cm wide × 5 cm) – 1 set
- Button (2 cm diameter)

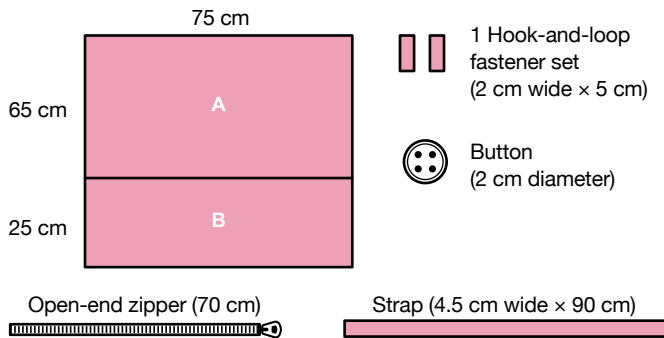

1 Prepare the strap.

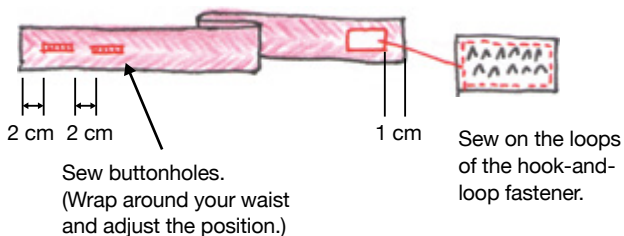

2 Attach the zipper between A and B. Use the zipper foot „I“ or Narrow Zipper Foot F079 (sold separately).

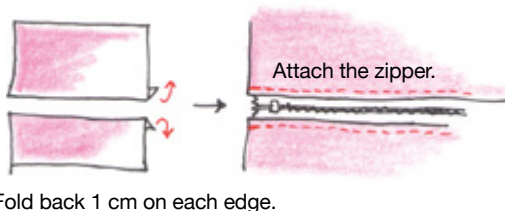

3 Fold back 2.5 cm on the edge, and then sew with a zigzag stitch.

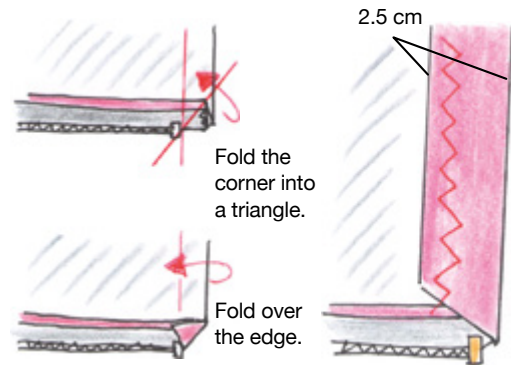

Do the same on the left and right sides of the top and bottom pieces (A and B).

4 Fold over the edge at the waist, and then try it on to determine the position for the hook-and-loop fastener.

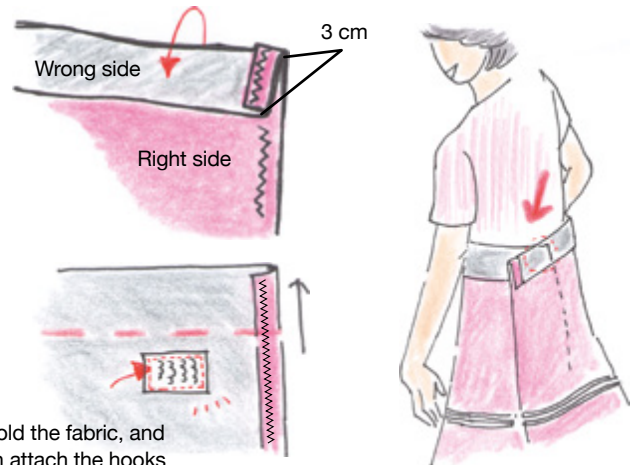

Unfold the fabric, and then attach the hooks of the hook-and-loop fastener at the point where it meets the corner on the left edge.

5 Attach the belt. Sew on the belt so that it covers the folded end.

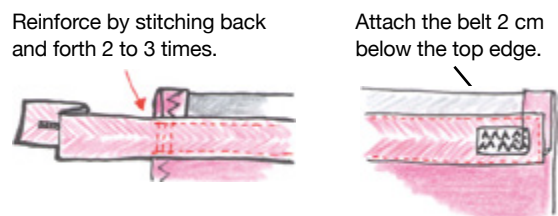

6 Attach the button to complete the project. Enjoy using the apron while adjusting its length, for example, long when cooking and short when gardening.





CREATION

12 Extend your sewing workspace.

The extension table allows you to accommodate larger and bulky projects. Thus, sewing large items, like tablecloths, or bulky items like heavyweight totes, is made easy and comfortable when the extension table (optional) is used.

Applications



With a wide table the fabric is kept stable, making it easy to achieve a beautifully sewn finish. Article No.: WT15

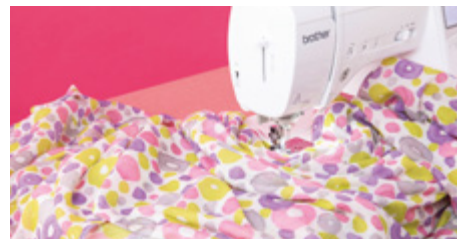

Long skirts and tablecloths...
Easily sew large items!

Poncho-style tunic top

1. If there are no instructions to use a specific stitch, use the straight stitch.
2. Presser foot "J" (straight stitch) will be used.



This fashionable item can be easily made by simply sewing along the edges of a square piece of fabric. It can be worn as a blouse or a bathing suit cover-up.

Materials

- Cotton print (90 cm wide × 280 cm)

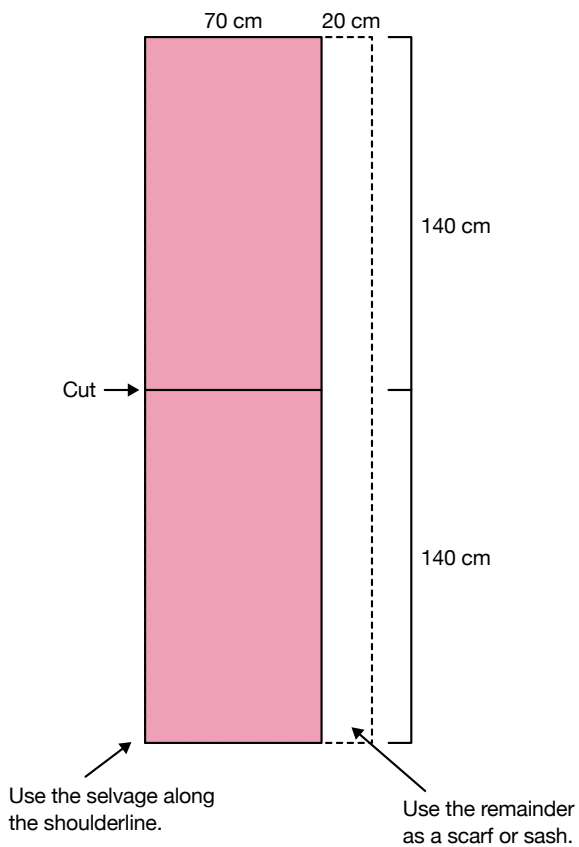

- 1 With their right sides together, sew together the front and back along the shoulders. Leave a 32 cm opening at the center.

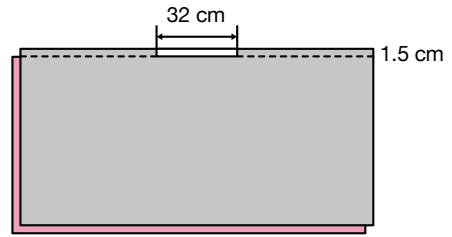

- 2 Fold back twice and stitch about 5 mm of the seam allowance around the opening.

Fold over 5 mm.

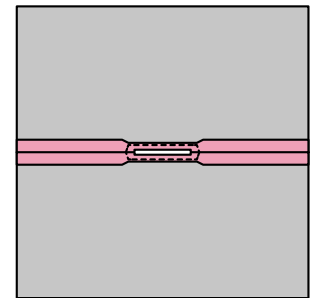
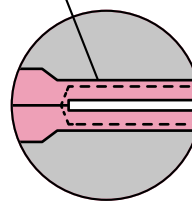

- 3 Fold over 5 mm + 1 cm and stitch along all edges.

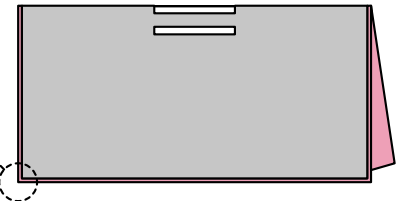
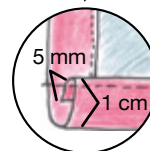
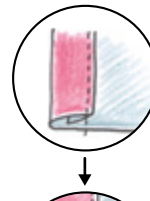

- 4 Secure with stitching 12 cm from the top.

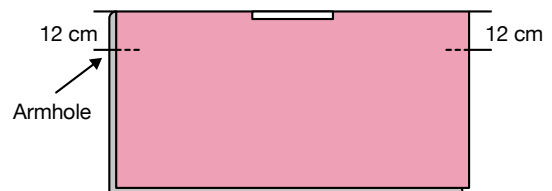

This square cloth drapes beautifully when worn as is, but is also fashionable with tucks sewn in.

CREATION

13 Sew accents with decorative stitches such as zigzag and overcast.

Further enhance your design by sewing decorative tape, ribbons, sequin strings, etc., using a zigzag stitch. Equipped with simple and practical stitch patterns such as overcasting, blind hem and appliqué.

We recommend using presser foot "N" and needle #11. Attach backing material for neat finishes when sewing patterns.



Slippers

1. If there are no instructions to use a specific stitch, use the straight stitch.
2. Presser foot "J" (straight stitch/zigzag stitch) will be used.



These slippers are made from thick felt. Three-dimensional items may seem difficult to make, but even beginners can complete the project if they carefully sew according to the instructions. When inserting pins into thick fabric, be careful not to poke your fingers.

Some models may not have functions used for the sample shown in the photo.

Materials

- Fabric for upper and thick felt for sole (65 cm wide × 28 cm)
- Jersey for insole (25 cm wide × 28 cm)
- Stabilizer (25 cm wide × 28 cm)

Draw joining marks with an erasable pen.



Fabric for upper

Thick felt for sole

Jersey for insole

Stabilizer
Cut 1 cm smaller than the pattern.

Flip over the pattern, and then cut it out to make a left and a right slipper.

- 1 Affix stabilizer to the wrong side of the insole.

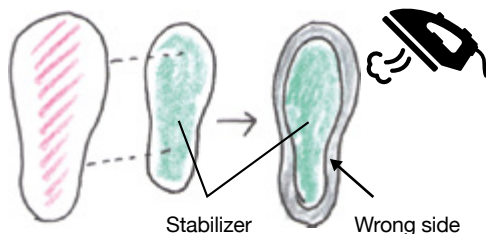

Stabilizer

Wrong side

- 2 With right sides out, sew together the sole (felt) and the insole made in step 1 with stitching along the edge and a 1 cm seam allowance.

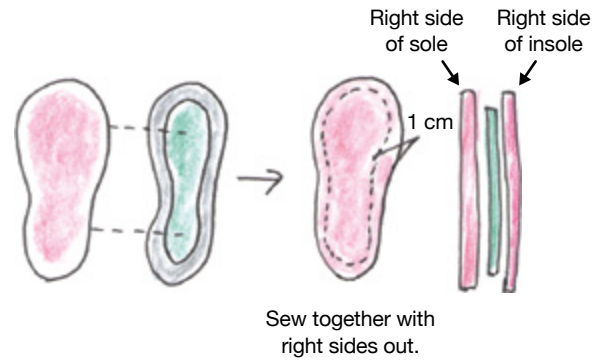

Sew together with right sides out.

- 3 Sew decorative stitching on the upper.



Select a decorative stitch and sew your custom design.

You can even simply sew zigzag stitching with different thread colors.

- 4 With the right side of the upper in, stitch the heel.

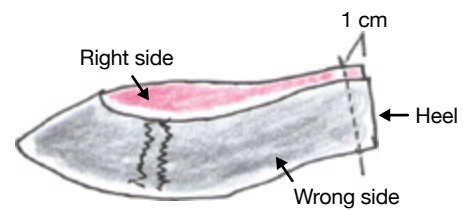

- 5 Pin together the upper and sole at the joining marks, and then sew them together from the right side.

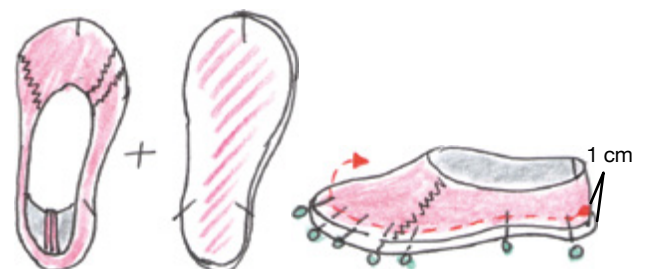

Insert the pins perpendicular to the sewing direction.

Copyright© Brother Industries, Ltd. All Rights Reserved.



CHAPTER

03

STITCH
OVERVIEW
AND
PROFILE



Innov-is A-Series Built-in Stitch Patterns

A16



16 Stitches

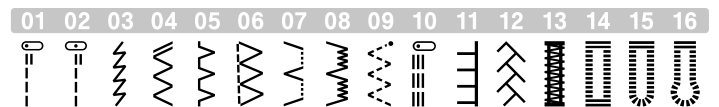

A50



50 Stitches



| | | | | | | | | | | | | | | | | |
|----|----|----|----|----|----|----|----|----|----|----|----|----|----|----|----|----|
| 01 | 02 | 03 | 04 | 05 | 06 | 07 | 08 | 09 | 10 | 11 | 12 | 13 | 14 | 15 | 16 | 17 |
| 01 | 02 | 03 | 04 | 05 | 06 | 07 | 08 | 09 | 10 | 11 | 12 | 13 | 14 | 15 | 16 | 17 |
| 18 | 19 | 20 | 21 | 22 | 23 | 24 | 25 | 26 | 27 | 28 | 29 | 30 | 31 | 32 | 33 | 34 |
| 18 | 19 | 20 | 21 | 22 | 23 | 24 | 25 | 26 | 27 | 28 | 29 | 30 | 31 | 32 | 33 | 34 |
| 35 | 36 | 37 | 38 | 39 | 40 | 41 | 42 | 43 | 44 | 45 | 46 | 47 | 48 | 49 | 50 | |
| 35 | 36 | 37 | 38 | 39 | 40 | 41 | 42 | 43 | 44 | 45 | 46 | 47 | 48 | 49 | 50 | |

A60SE



60 Stitches



| | | | | | | | | | | | | | | | | | | | |
|----|----|----|----|----|----|----|----|----|----|----|----|----|----|----|----|----|----|----|----|
| 01 | 02 | 03 | 04 | 05 | 06 | 07 | 08 | 09 | 10 | 11 | 12 | 13 | 14 | 15 | 16 | 17 | 18 | 19 | 20 |
| 01 | 02 | 03 | 04 | 05 | 06 | 07 | 08 | 09 | 10 | 11 | 12 | 13 | 14 | 15 | 16 | 17 | 18 | 19 | 20 |
| 21 | 22 | 23 | 24 | 25 | 26 | 27 | 28 | 29 | 30 | 31 | 32 | 33 | 34 | 35 | 36 | 37 | 38 | 39 | 40 |
| 21 | 22 | 23 | 24 | 25 | 26 | 27 | 28 | 29 | 30 | 31 | 32 | 33 | 34 | 35 | 36 | 37 | 38 | 39 | 40 |
| 41 | 42 | 43 | 44 | 45 | 46 | 47 | 48 | 49 | 50 | 51 | 52 | 53 | 54 | 55 | 56 | 57 | 58 | 59 | 60 |
| 41 | 42 | 43 | 44 | 45 | 46 | 47 | 48 | 49 | 50 | 51 | 52 | 53 | 54 | 55 | 56 | 57 | 58 | 59 | 60 |

Innovís A-Series Built-in Stitch Patterns

A80



Stitch Pattern Plate Included

80 Stitches

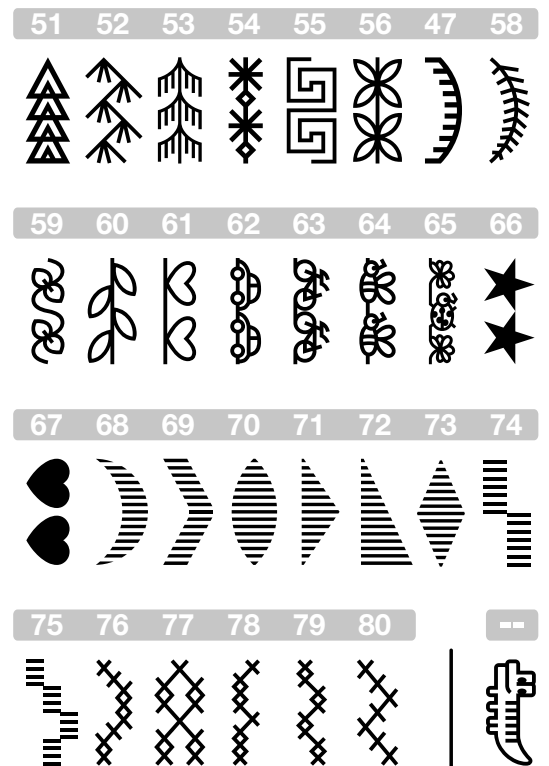
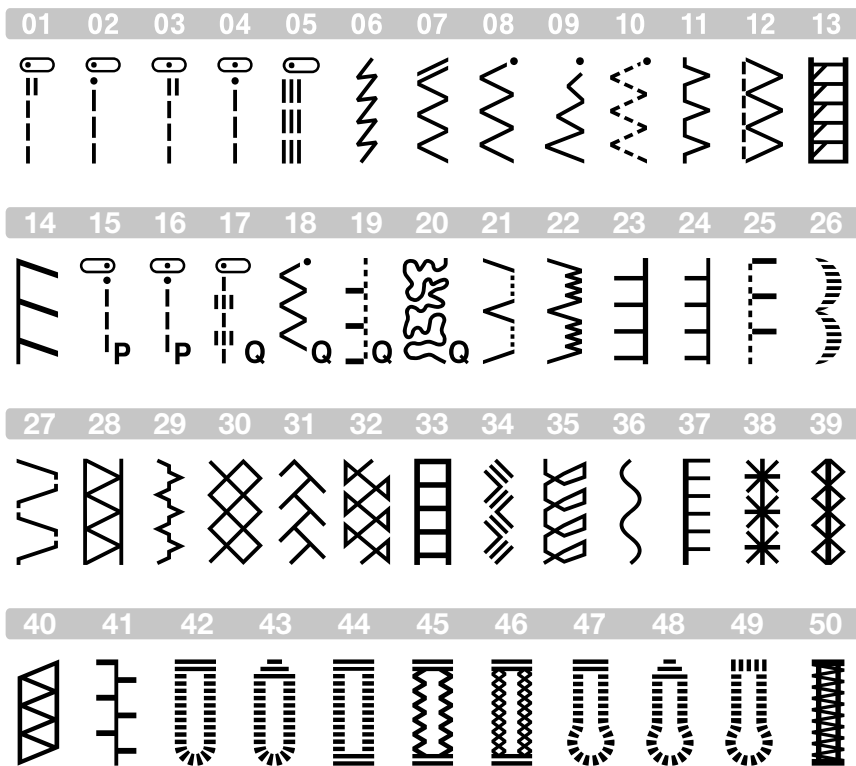

A150



Stitch Pattern Plate Included

150 Stitches + 4 Fonts*

| | | | | | | | | |
|--|-------------|-------------------------------|----------------------|----------------------|-------------------------------------|-------------------------------------|-------------------------------------|-------------------------------------|
| | | 01 02 03 04 05 06 07 08 09 10 | | 01 02 | | 01 02 | | 01 02 03 04 05 |
| 1 2 | 3 4 | 5 6 | 7 8 | 9 0 | 11 12 13 14 15 16 17 18 19 20 21 22 | 23 24 25 26 27 28 29 30 31 32 33 34 | 35 36 37 38 39 40 41 42 43 44 45 46 | 47 48 49 50 51 52 53 54 55 56 57 58 |
| 59 60 61 62 63 64 65 66 67 68 69 70 71 | 03 04 05 06 | 07 08 09 10 | 11 12 13 14 | 15 16 17 18 | 19 20 | 03 04 05 06 | 07 08 09 10 | 11 12 13 14 |
| 15 16 17 18 | 19 | 06 07 08 09 10 11 12 | 13 14 15 16 17 18 19 | 20 21 22 23 24 25 26 | 27 28 29 30 31 32 33 | 34 35 36 37 38 39 40 | | |

| | | | | | |
|----------------------------------|----------------------------------|----------------------------------|----------------------------------|----------------------------------|----------------------------------|
| AB | 01 02 03 04 05 06 07 08 09 | AB | 01 02 03 04 05 06 07 08 09 | AB | 01 02 03 04 05 06 07 08 09 |
| A B C D E F G H I | J K L M N O P Q R S | T U V W X Y Z 0 1 2 | 3 4 5 6 7 8 9 # % - | + × ÷ = * . , & ? ! | @ < > () [] / \ ~ |
| © ® ™ “ ” ’ ‘ ’ _ | Ä Å Æ Ç Ð Ñ Ö Ø Æ Ü ß | À Á Â Ã Ä Å Æ Ç Ð Ñ Ö Ø Æ Ü ß | À Á Â Ã Ä Å Æ Ç Ð Ñ Ö Ø Æ Ü ß | À Á Â Ã Ä Å Æ Ç Ð Ñ Ö Ø Æ Ü ß | À Á Â Ã Ä Å Æ Ç Ð Ñ Ö Ø Æ Ü ß |
| 70 71 72 73 74 75 76 77 78 79 80 | 70 71 72 73 74 75 76 77 78 79 80 | 70 71 72 73 74 75 76 77 78 79 80 | 70 71 72 73 74 75 76 77 78 79 80 | 70 71 72 73 74 75 76 77 78 79 80 | 70 71 72 73 74 75 76 77 78 79 80 |

あい

* 3 types of Alphabet, 1 type of Japanese

Innov'is A-Series Profile



A16

A50



| Sewing features | | |
|---|---------------------------|---------------------------|
| Total built-in stitches | 16 | 50 |
| One-step buttonhole styles | 3 | 5 |
| Built-in lettering fonts | - | - |
| Advanced one-action needle threader | ✓ | ✓ |
| Stitch selection | Jog dial | Electronic jog dial |
| Workspace area | 162 × 103 mm (6.2 × 4.1") | 162 × 103 mm (6.2 × 4.1") |
| Reinforcement/Lock stitch button | ✓ | ✓ |
| LCD size | 2,61" | 2,61" |
| Automatic reverse/reinforcement stitch | ✓ | ✓ |
| Needle up/down button | ✓ | ✓ |
| Automatic thread cutter | - | - |
| Thread tension | ✓ | ✓ |
| Easy bobbin winder (with thread cutter) | ✓ | ✓ |
| Twin needle function | - | ✓ |
| 7 point feed dog | ✓ | ✓ |
| Drop feed | ✓ | ✓ |
| Maximum sewing speed | 850 spm | 850 spm |
| Included accessories | | |
| Hard case | - | - |
| Soft cover | ✓ | ✓ |
| Foot controller | ✓ | ✓ |
| Zigzag foot | ✓ | ✓ |
| Buttonhole presser foot | ✓ | ✓ |
| Overcasting stitch foot | ✓ | ✓ |
| Transparent presser foot | - | ✓ |
| Blind stitch foot | ✓ | ✓ |
| Zipper foot | ✓ | ✓ |
| Button sewing foot | ✓ | ✓ |
| Eyelet punch | - | ✓ |
| Optional accessories | | |
| Wide table WT15 | WT15 | WT15 |
| Creative Quilting Kit QKM2 | QKM2 | QKM2 |
| Creative Sewing Pack II CSP2 | CSP2 | CSP2 |
| Circular Attachment CIRC1 | CSP1 | CSP1 |
| Bobbin Work Kit BWRK1 | BWRK1 | BWRK1 |
| Wide range of special feet available | ✓ | ✓ |

For the full range of accessories available contact your dealer or visit sewingcraft.brother.eu

| A60 | A80 | A150 |
|---|---|---|
|  |  |  |
| 60 | 80 | 150 |
| 6 | 8 | 10 |
| - | - | [4] 3 types of Alphabet 1 type of Japanese |
| ✓ | ✓ | ✓ |
| Electronic jog dial | Electronic jog dial | Key pad |
| 162 × 103 mm (6.2 x 4.1") | 162 × 103 mm (6.2 x 4.1") | 162 × 103 mm (6.2 x 4.1") |
| ✓ | ✓ | ✓ |
| 2,61" | 2,61" | 3,64" |
| ✓ | ✓ | ✓ |
| ✓ | ✓ | ✓ |
| - | - | ✓ |
| ✓ | ✓ | ✓ |
| ✓ | ✓ | ✓ |
| ✓ | ✓ | ✓ |
| ✓ | ✓ | ✓ |
| ✓ | ✓ | ✓ |
| 850 spm | 850 spm | 850 spm |
| ✓ | ✓ | ✓ |
| - | - | ✓ |
| ✓ | ✓ | ✓ |
| ✓ | ✓ | ✓ |
| ✓ | ✓ | ✓ |
| ✓ | ✓ | ✓ |
| ✓ | ✓ | ✓ |
| ✓ | ✓ | ✓ |
| ✓ | ✓ | ✓ |
| ✓ | ✓ | ✓ |
| ✓ | ✓ | ✓ |
| WT15 | WT15 | WT15 |
| QKM2 | QKM2 | QKM2 |
| CSP2 | CSP2 | CSP2 |
| CSP1 | CSP1 | CSP1 |
| BWRK1 | BWRK1 | BWRK1 |
| ✓ | ✓ | ✓ |

CHAPTER

04

SUPPORT CENTER

Innov-is A-Series App

Access useful information directly from your smartphone or tablet through the Brother SupportCenter app!



**Operation Manual
PDF viewer**



**Best suggested combination
of fabric, needle and thread**



**How to use standard and
optional accessories**



Stitch pattern chart



**How-to-use and How-to-make
short videos**

Brother SupportCenter is a mobile App providing the latest support information for your Brother product. The free and easy-to-use App gives you access to set up information, product manuals, Frequently Asked Questions and troubleshooting tips.

Download FREE from the App Store or Google Play



Innov-is MOVIE INDEX

List of How-to-Make Short Videos

 [Click here for instruction videos](#)

| Video | Details |
|---|--|
| Lesson 1  | Creation 01: Big canvas tote bag Learn to sew a canvas tote bag and how to hem denim easily. |
| Lesson 2  | Creation 03: Long skirt made of lightweight fabric Learn to sew a ruffled long skirt made of thin fabric. |
| Lesson 3  | Creation 04: French-sleeve T-shirt Creation 05: Upcycled frilly T-shirt Learn to sew a stretchy t-shirt. |
| Lesson 4  | Creation 06: Buttoned pouch Creation 07: Buttoned napkin ring Making buttonholes on the Brother Innov-is A-series is super easy. Learn to make a napkin ring and cute button clutch. |
| Lesson 5  | Creation 09: Frock for Kids Learn to sew a cute frock for a special little lady. |
| Lesson 6  | Creation 10: Synthetic leather zippered pouch Creation 11: Zippered convertible apron Learn to insert a zipper fuss-free! Follow this tutorial that will teach you how to insert a zipper into an apron and a pouch. |
| Lesson 7  | Creation 10: Synthetic leather bag / Synthetic leather key case / Synthetic leather zippered pouch Ever wondered how to sew on pleather and other synthetic fabrics? Learn how to sew a bag and pouch. |
| Lesson 8  | Creation 12: Poncho-style tunic top It is easy to sew bulky or large items using a wide extension table for your sewing machine. Learn how to sew a poncho style tunic. |
| Lesson 9  | Creation 13: Slippers You can do so much more than just straight sewing with the Brother Innov-is A-series sewing machines. Have a look at the great range of decorative stitches and learn to sew some felt slippers. |
| Lesson 10  | With the Brother Innov-is A150 sewing machine, you can use the built-in lettering styles to personalise items, like table napkins. Let us show you how. |

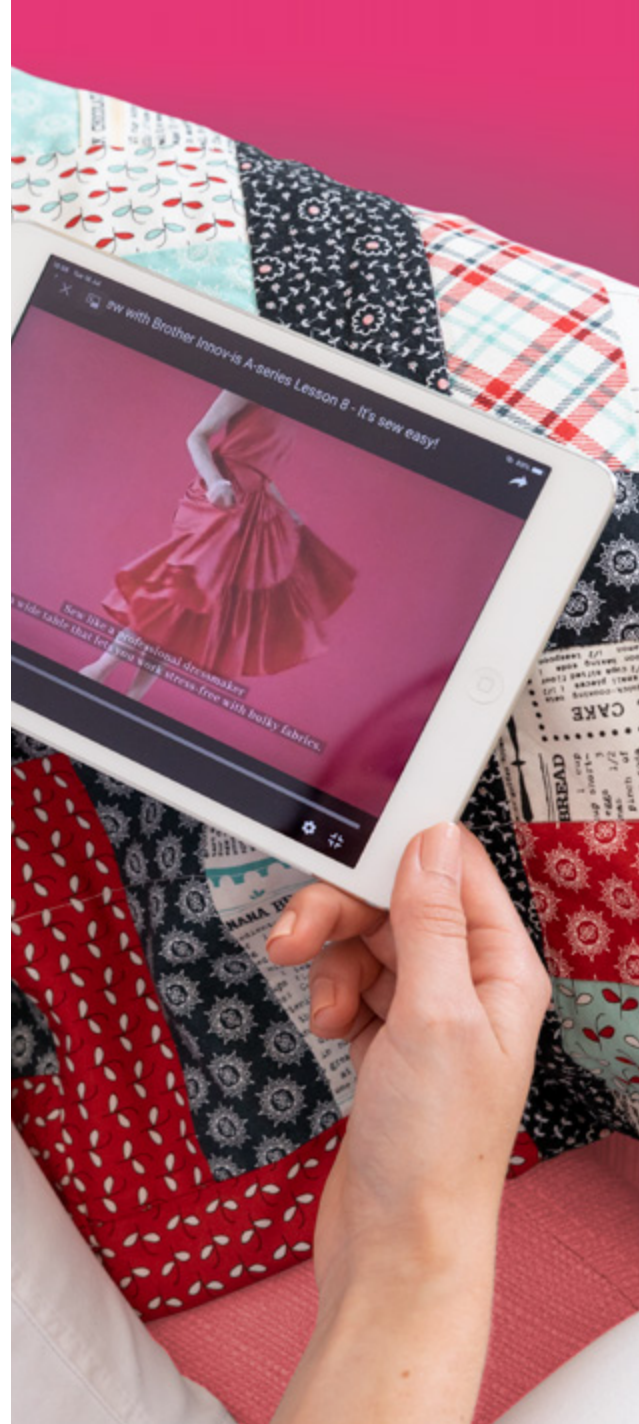

brother
at your side



   @BrotherSewingUK

Brother Sewing Machines Europe GmbH UK Branch
Shepley Street, Audenshaw, Manchester M34 5JD
sewingcraft.brother.eu

